

NOTE: DIMENSIONS LOCATED IN BOXES ARE COMMON
 SETBACK DIMENSIONS FOR EACH FITTING

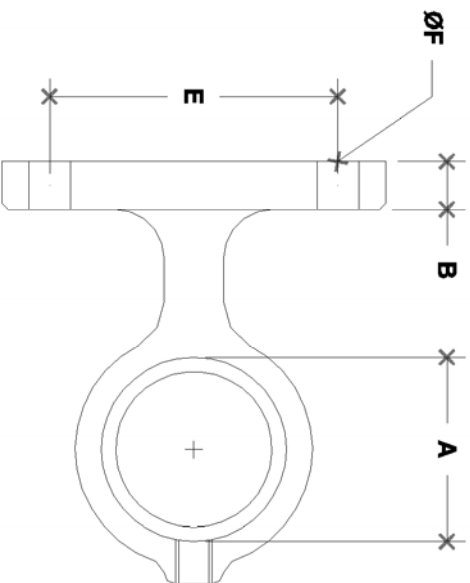
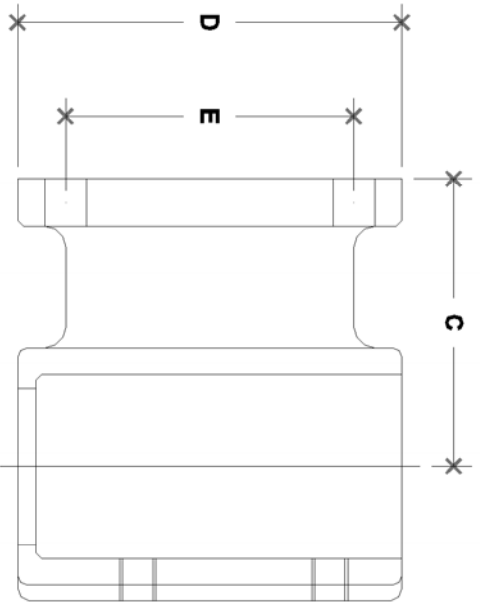

#54-3 Offset Wall Flange (3")

SCALE: HALF

ENGLISH UNITS (Inches)						
PIPE SIZE	A	B	C	D	E	F
1 1/2"	1.93	0.50	3.00	4.00	3.00	0.44

METRIC UNITS (mm)						
PIPE SIZE	A	B	C	D	E	F
1 1/2"	49	13	76	102	76	12