

NOTE: DIMENSIONS LOCATED IN BOXES ARE COMMON
SETBACK DIMENSIONS FOR EACH FITTING

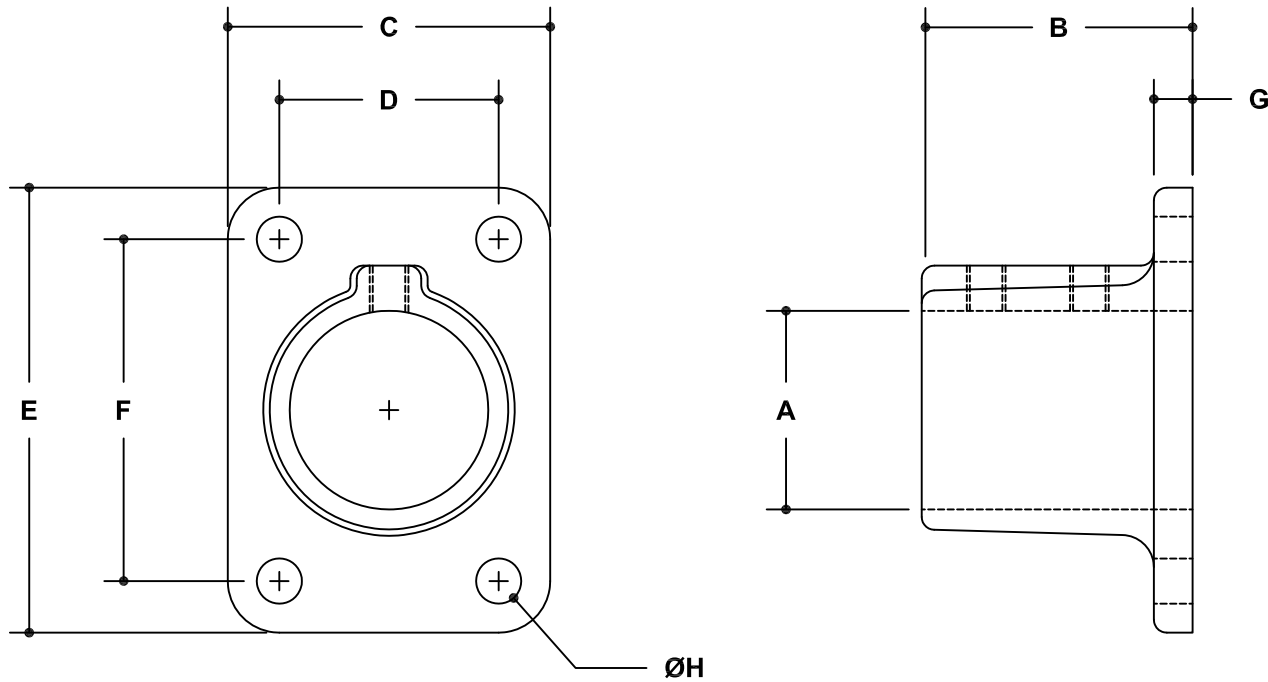

#47 Rectangular Base Flange

SCALE: HALF

ENGLISH UNITS (Inches)									
PIPE SIZE	A	B	C	D	E	F	G	H	J
2"	2.40	2.88	3.75	2.63	5.00	3.75	0.38	0.44	
1½"	1.93	2.53	3.13	2.13	4.31	3.25	0.38	0.44	
1¼"	1.68	2.13	2.94	1.88	4.06	3.00	0.31	0.44	
1"	1.34	1.81	2.38	1.44	3.50	2.63	0.28	0.31	
¾"	1.07	1.75	1.88	2onCL	3.50	2.63	0.25	0.31	

METRIC UNITS (mm)									
PIPE SIZE	A	B	C	D	E	F	G	H	J
2"	61	45	95	67	127	95	10	12	
1½"	49	46	80	54	109	83	10	12	
1¼"	43	54	75	48	76	76	8	12	
1"	34	64	60	36	89	67	6	8	
¾"	27	73	48	2onCL	89	67	6	8	